

Viking™ L

Mobile Lift

Service Manual

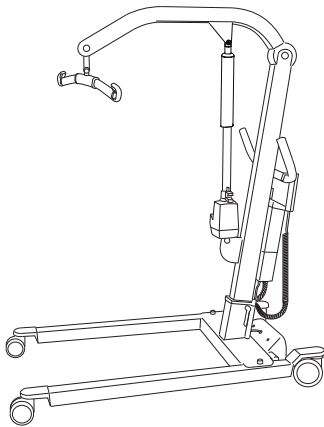

Prod. No. 2040004
S/N 7 200 201- 7 300 300
DISCONTINUED 2013

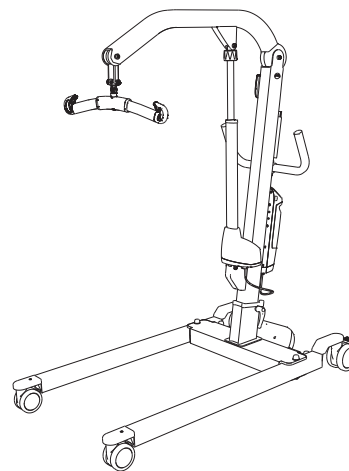

Prod. No. 2040014
S/N 7 800 001- 7 900 000
DISCONTINUED 2017

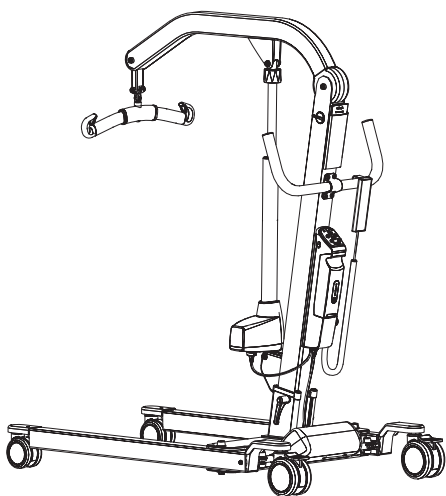

Prod. No. 2040034
S/N 9 300 001- 9 400 000
DISCONTINUED 2017

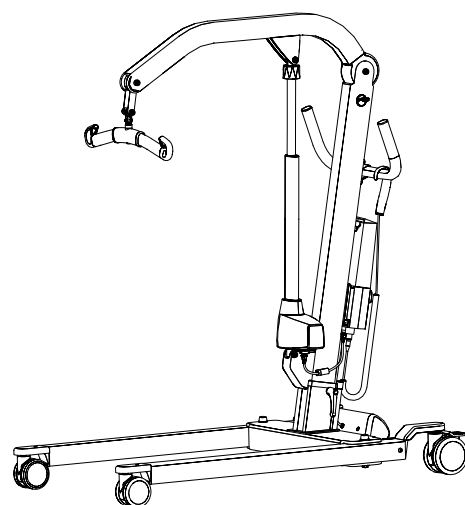

Prod. No. 2040044
S/N 9 500 001- 9 600 000

 *In this document, this warning symbol indicates that special care should be taken. If instructions are not followed there is a risk of serious injury to patient or caregiver.*

Spare part statement

Liko AB will as a manufacturer of overhead & mobile lifts keep spare parts available for 10 years after the last manufacturing date of the product.
Spare parts are available in the spare parts list or in the Service Manual for each model of lift.
Components (manufacturing parts) are not available after last manufacturing date.

Repairs and maintenance may only be performed by personnel authorized by Hill-Rom and using original Liko™ spare parts.
For information regarding Service and Maintenance education, contact your Hill-Rom representative.
For contact information please visit our website: www.hill-rom.com | www.liko.com

Table of Contents

Viking™ L mobile lift

	<u>Page</u>
1.0 Technical Data	
1.1 Viking L 2040004	4
1.2 Viking L 2040014	5
1.3 Viking L 2040034	6
1.4 Viking L 2040044	7
2.0 Troubleshooting	
2.1 Viking L 2040004	8
2.2 Viking L 2040014	9
2.3 Viking L 2040034	10
2.4 Viking L 2040044	11
2.5 Control Unit CBL	12
3.0 Spare Parts Assembly information	13
4.0 Spare Parts List	
4.1 Viking L 2040004	14
4.2 Viking L 2040014	18
4.3 Viking L 2040034	22
4.4 Viking L 2040044	26
5.0 Service	
5.1 Control Unit CBL, parameter Code Key	30
5.2 Control Unit CBL, Reset Service Interval Parameters.....	31
5.3 Control Unit Jumbo Care	32
6.0 Liko™ Service System.....	33
7.0 Periodic Inspection Information.....	34
8.0 Preventive Maintenance	35
9.0 Product Changes.....	36

1.1 Technical Data Viking™ L mobile lift, 2040004

Lifting speed: 3.5 cm/s (0.8 inch./s) without load

Batteries: Two 12 V, 2.9 Ah, valve-regulated lead-acid gel-type batteries. New batteries are provided by the supplier.

Battery Built-in charger, 100-240 V AC, max 400 mA

Motor (mast): 24 V, 10.8 A, permanent magnetic motor with mechanical safety mechanism, safety nut and outer tube.

Motor (base): 24 V, 5.5 A, permanent magnetic motor.



Material: Aluminium

Emergency lowering: Mechanical and electrical

Wheels: Standard front: 100 mm dual.
Standard rear: 125 mm dual w. brake.
Alt. front: 75 mm dual.
Alt. rear: 100 mm single w. brake.

Intermittent operation: Int. Op 10/90, active operation max 2 min. Out of a time of 100, active must be less than 10, though not more than 2 min.

Degree of protection: IP 43

-  Built for indoor operation.
-  Type B according to the degree of protection against electric shock.
-  Class II equipment.

Measurements

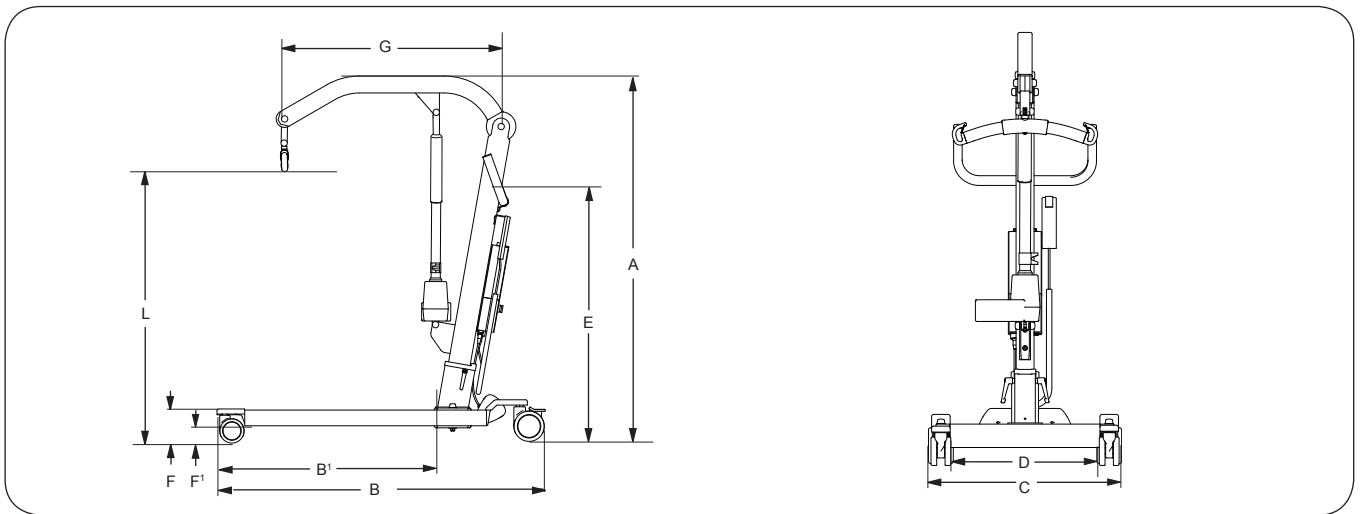

Maximum load and weight in kg. Measures in mm.

Model	Wheel diameter	Max. load	L Max	L Min	A Max	A Min	B	B'	C	D	E	F	F'	G	Weight tot	Weight part	Turning diameter
Viking L	100/125 *	250	1790	450	2000	1360	1350	900	660-960	550-950	1060	140	45	900	40	22	1420
Viking L	75/100	250	1780	440	1990	1350	1350	900	660-960	550-950	1050	120	35	900	40	22	1420

* Standard for Viking L.

Maximum load and weight in lbs. Measures in inches.

Model	Wheel diameter	Max. load	L Max	L Min	A Max	A Min	B	B'	C	D	E	F	F'	G	Weight tot	Weight part	Turning diameter
Viking L	3.9/4.9*	550	70	18	79	54	53	35	26-38	22-37	42	5.5	1.8	35	88	48	60
Viking L	3.0/3.9	550	70	18	79	54	53	35	26-38	22-37	42	4.7	1.4	35	88	48	60

* Standard for Viking L.

1.2 Technical Data Viking™ L mobile lift, 2040014

Maximum load: 250 kg (550 lbs)

Material: Aluminium

Weight: Total weight: 36.5 kg (80 lbs)
Heaviest part: 20.5 kg (45 lbs)

Wheels: Front: 100 mm (4 in) twin wheels.
(Or 75 mm* (3 in) twin wheels).
Rear: 125 mm (5 in) twin wheels.
(Or 100 mm (4 in) single castors with brakes).

Turning diameter: 1460 mm (57.4 in)

Emergency Lowering: Mechanical and electrical

Lifting interval: 1330 mm (52.4 in)

Lifting Speed (no load): 21 mm/s and 13 mm/s, respectively
0.8 in/s and 0.5 in/s,

Sound Level: 51 dB(A)

Protection Class: IP X4

Operating Forces of Controls: HandControl: 4 N
Operation Panel: 4 N

HandControl IR: Batteries: 2 AAA LR03 1.5 V.
Reach: 2 m (80 in)

Electrical Data: 24 V



Intermittent operation: Int. Op 10/90, active operation max 2 min. Only 10% of a given length of time may be active, yet no more than 2 min.

Batteries: NiMH cells, 2.2 Ah. New batteries provided by the supplier.

Battery Charger: CBL20001, built-in, 100-240 V AC, 50-60 Hz, max 600 mA.

Lift Motor: Permanent magnet motor with mechanical safety mechanism
24 V, 6.4 A

Motor for base-width adjustment: Permanent magnet motor
24 V, 6 A

-  The device is intended for use indoors
-  Type B, in accordance with the electrical shock protection class.
-  Class II equipment.

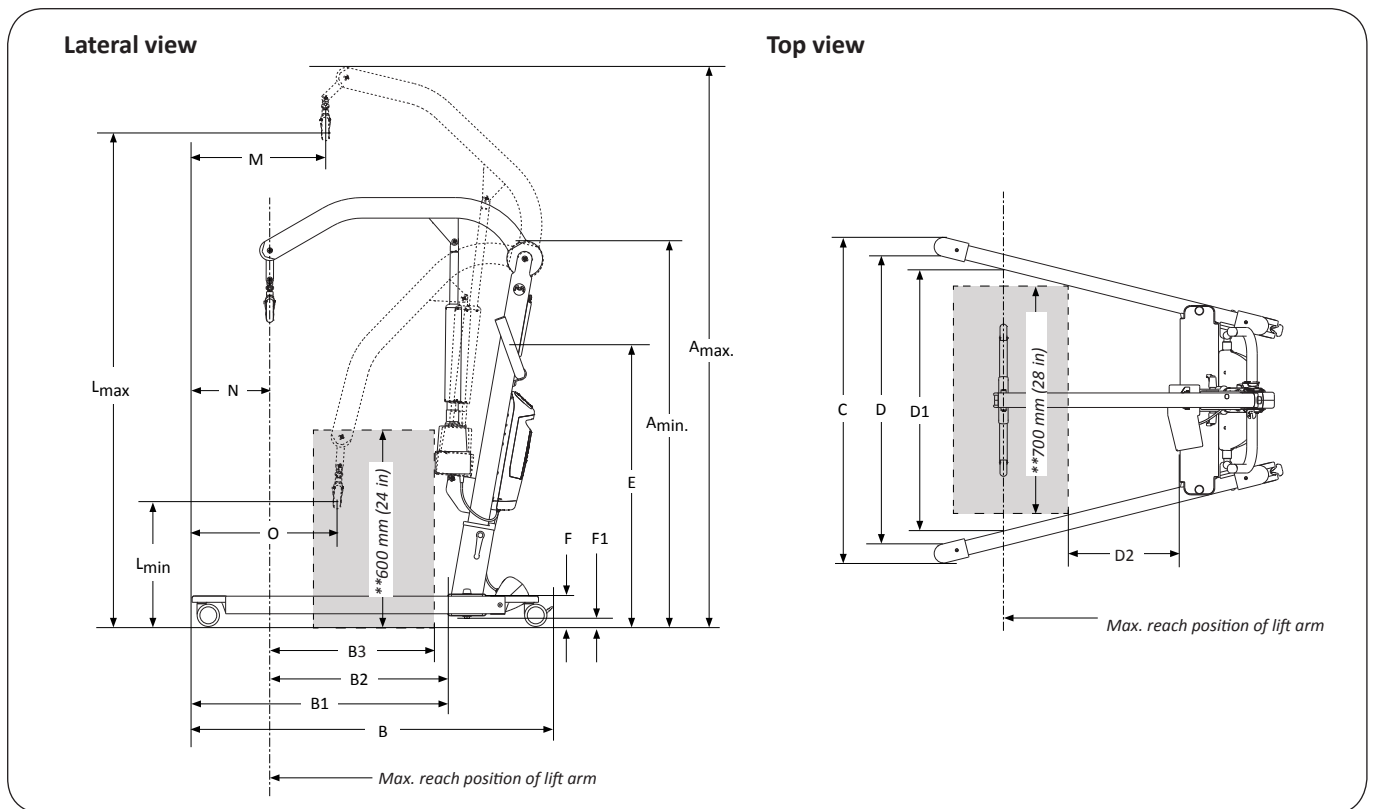

Measures in mm

A _{max}	A _{min}	B	B ₁	B ₂	B ₃ **	C		D		D ₂ **	E	F	F ₁	L _{max}	L _{min}	M	N	O
						max	min	max	min									
2030	1390	1360	900	630	560	1070	695	950	625	230	1060	165	43	1790	460	500	280	550

Measures in inch.

A _{max}	A _{min}	B	B ₁	B ₂	B ₃ **	C		D		D ₂ **	E	F	F ₁	L _{max}	L _{min}	M	N	O
						max	min	max	min									
80.0	54.7	53.5	35.4	24.8	22.0	42.1	27.4	37.4	24.6	9.1	41.7	6.5	1.7	70.5	18.1	19.7	11.0	21.7



Note: The measurements are based on the lift being equipped with standard sling bar and standard wheels. When changing to other lifting accessories, or other wheels, check that the lift still achieves desired lifting height.

** Reference measurement according to Standard EN ISO 10535:2006.

1.3 Technical Data Viking™ L mobile lift, 2040034

Maximum load: Viking L: 250 kg (550 lbs)
Material: Aluminium
Weight: Total weight: 37,4 kg (82.5 lbs)
 Heaviest part: 21,6 kg (47.6 lbs)
Wheels: Front: 100 mm (4 in) twin wheels.
 Rear: 125 mm (5 in) twin wheels.
Turning diameter 1460 mm (57.4 in)
Emergency lowering device: Mechanical and electrical
Lifting interval: 1330 mm (52.4 in)
Lifting speed (no load) 21 mm/s and 13 mm/s, respectively
 (0.8 in/s and 0.5 in/s, respectively)
Sound level: 51 dB(A)
Protection class: IP X4
Operating Forces of Controls: HandControl: 2.4 N
 Operation Panel: 4 N

Electrical data: 24 V
Intermittent power: Int. Op 10/90, active operation max 2 min. Only 10% of a given length of time may be active, but no more than 2 min.
Batteries: NiMH cells, 2.2 Ah. New batteries provided by the supplier.
Battery charger: CBL20002, built-in, 100-240 V AC, 50-60 Hz, max 600 mA.
Lift motor: Permanent magnet motor with mechanical safety mechanism
 24 V, 6.4 A
Motor for base-width adjustment: Permanent magnet motor
 24 V, 6 A

-  The device is intended for use indoors
-  Type B, in accordance with the electrical shock protection class.
-  Class II equipment.

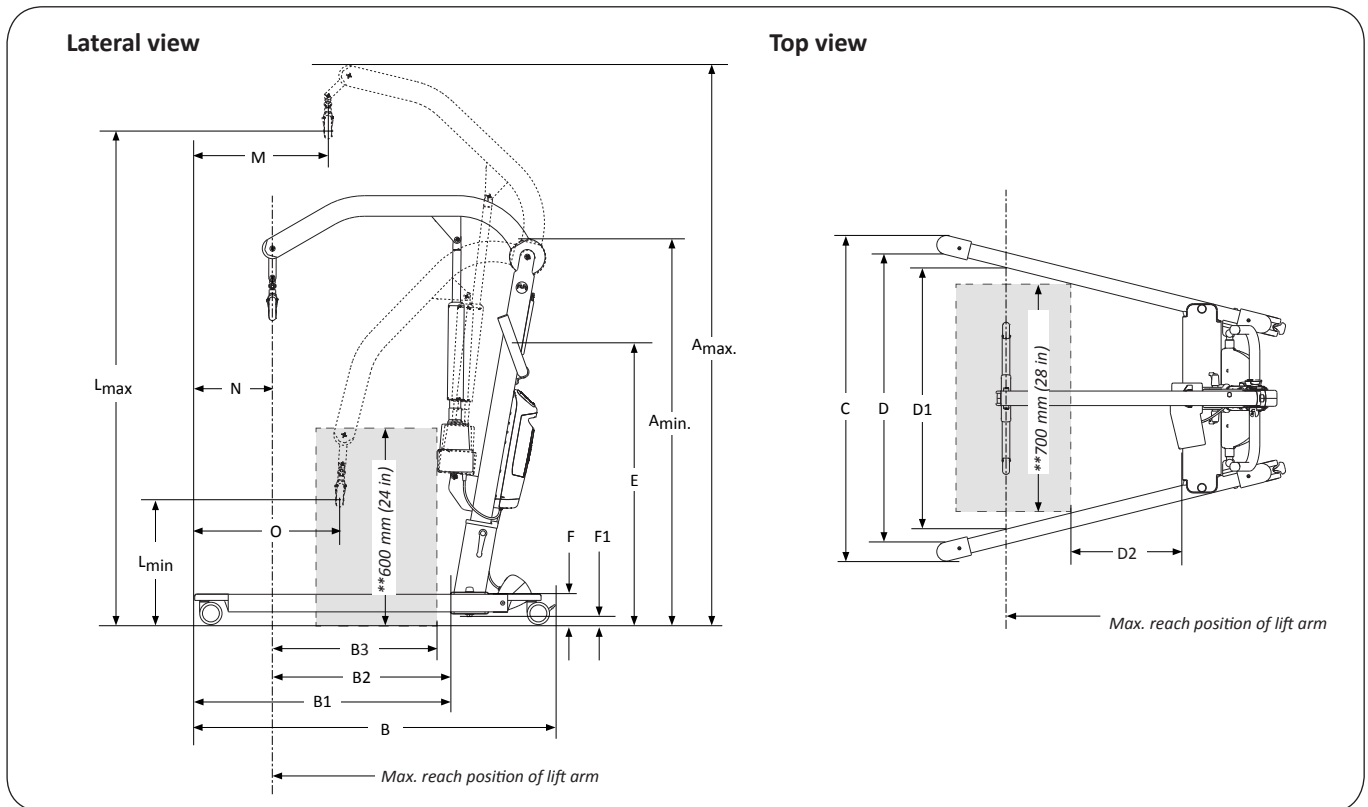

Measures in mm

A _{max}	A _{min}	B	B ₁	B ₂	B ₃ **	C		D		D ₂ **	E	F	F ₁	L _{max}	L _{min}	M	N	O
						max	min	max	min									
2030	1390	1360	900	630	560	1070	695	950	625	230	1060	165	43	1790	460	500	280	550

Measures in inch.

A _{max}	A _{min}	B	B ₁	B ₂	B ₃ **	C		D		D ₂ **	E	F	F ₁	L _{max}	L _{min}	M	N	O
						max	min	max	min									
80.0	54.7	53.5	35.4	24.8	22.0	42.1	27.4	37.4	24.6	9.1	41.7	6.5	1.7	70.5	18.1	19.7	11.0	21.7



Note: The measurements are based on the lift being equipped with standard sling bar and standard wheels. When changing to other lifting accessories, or other wheels, check that the lift still achieves desired lifting height.

** Reference measurement according to Standard EN ISO 10535:2006.

1.4 Technical Data Viking™ L mobile lift, 2040044

Maximum load: 250 kg (550 lbs)
Material: Aluminium
Weight: Total: 36,7 kg (81.0 lbs)
Heaviest part: 21,6 kg (47.6 lbs)
Wheels: Front: 100 mm (4 in) twin wheels.
Rear: 125 mm (5 in) twin wheels.
Turning diameter: Viking L: 1460 mm (57.4 in)
Emergency lowering device: Mechanical and electrical
Lifting interval: 1330 mm (52.4 in)
Lifting speed (no load): 23 mm/s and 17 mm/s
(0.9 in/s and 0.7 in/s)
Sound level: 51 dB(A)
Protection class: IP X4
Operating Forces of Controls: Handcontrol: 5 N
Electrical data: 24 V

Intermittent power: Int. Op 10/90, active operation max 2 min. Only 10% of a given length of time may be active, but no more than 2 min.
Batteries: Lead-acid gel, valve-regulated battery
24 V 2.9 Ah Prod. No. 2006106.
Weight: 2,8 kg (6.2 lbs.)
Li-ION battery
25.6 V, 3.3 Ah Prod. No. 2006110.
Weight: 1,4 kg (3.1 lbs.)
Battery charger: Internal charger, 100-240 V AC, 50-60 Hz, max. 400 mA.
Lift motor: Permanent magnet motor with mechanical safety mechanism. 24 V, 8.0 A
Motor for base-width adjustment: Permanent magnet motor
24 V, 5,5 A
Surrounding functional environment: Temperature: +10°C to +40°C, (50° F to 104° F)
Humidity: 20% to 80% at 30°C non-condensing,
Air pressure: 800HPa to 1060HPa, Altitude: max. 2000m.

-  The device is intended for use indoors
-  Type B, in accordance with the electrical shock protection class.
-  Class II equipment.

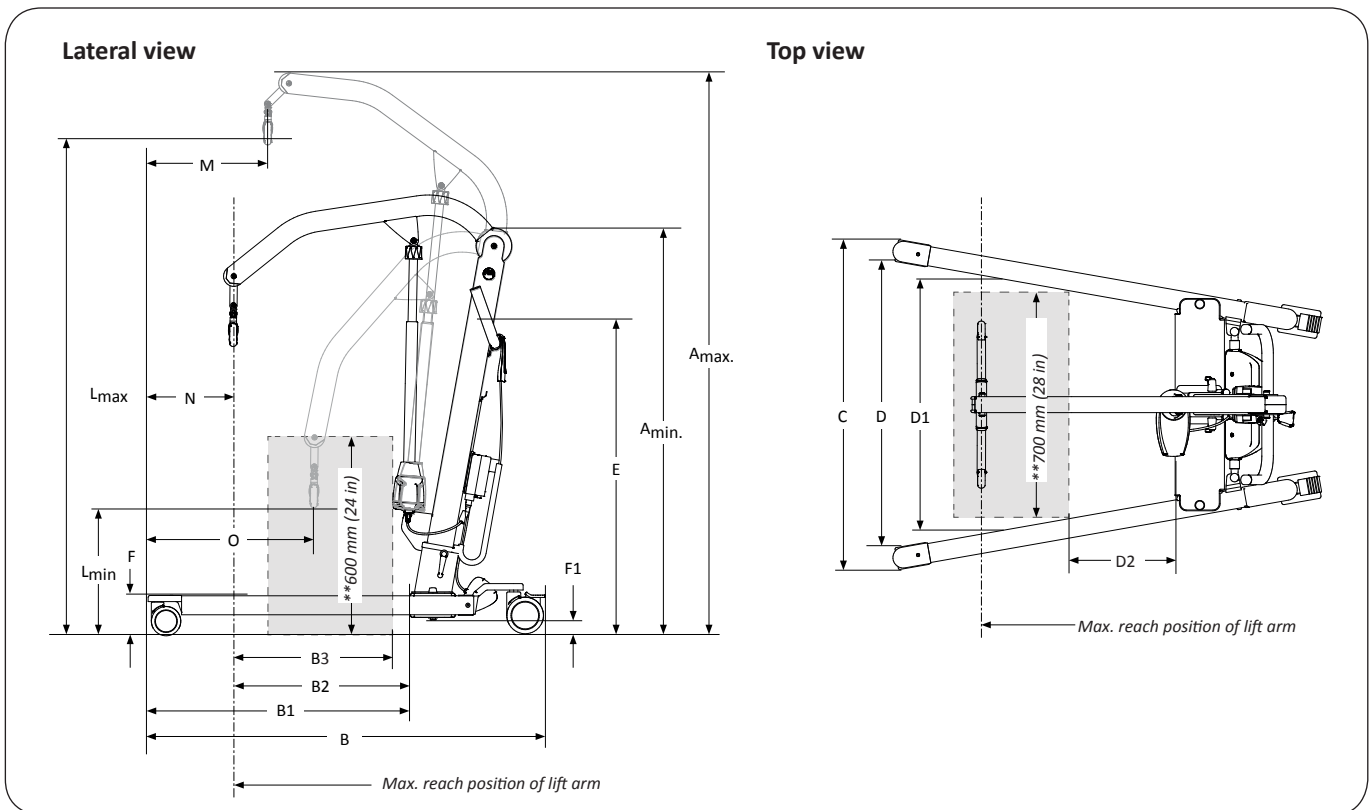

Viking L											Measurements: mm / in							
Amax	Amin	B	B1	B2	B3**	C		D		D2**	E	F	F1	Lmax	Lmin	M	N	O
						max	min	max	min									
2030	1390	1360	900	630	560	1070	695	950	625	230	1060	140	43	1790	460	500	280	550
80.0	54.7	53.5	35.4	24.8	22.0	42.1	27.4	37.4	24.6	9.1	41.7	5.5	1.7	70.5	18.1	19.7	11.0	21.7

Note: The measurements are based on the lift being equipped with standard sling bar. When changing to other lifting accessories, check that the lift still achieves desired lifting height.

** Reference measurement according to Standard EN ISO 10535:2006.

2.1 Trouble Shooting Viking™ L mobile lift, 2040004

**The lift does not work up/down.
Width adjustment does not
work in/out.**



1. Check that the emergency stop button is not pushed in .
2. Check that the cables are correctly connected .
3. Check that the charger cable is not connected to the wall socket.
4. Check that the battery is charged .
5. Check that the contact plates of the battery are not defective or broken off.
6. *If the lift still does not work satisfactorily, contact Hill-Rom.*

**Battery charging does not
work.**



1. Check that the emergency stop button is not pushed in .
2. Check to ensure that the wall socket is power-supplied.
3. Check to ensure that the charger cable is correctly connected .
4. Check that the contact plates of the battery box are not defective or broken off.
5. *If the lift still does not work satisfactorily, contact Hill-Rom.*

**The lift stops in the elevated
position.**



1. Check that the emergency stop button is not pushed in .
2. Use the electrical emergency lowering (marked) to safely lower the patient .
3. Use the mechanical emergency lowering (marked) to safely lower the patient .
4. Check that the battery is charged.
5. *If the lift still does not work satisfactorily, contact Hill-Rom.*

If you hear unusual sounds.



Contact Hill-Rom.

2.2 Trouble Shooting Viking™ L mobile lift, 2040014

The lift does not work up/down with the HandControl IR.

The base-width adjustment doesn't work (in/out) with the HandControl IR.



1. Make sure that the emergency stop is not engaged.
2. If the lift has not been used for 24 hours, enable the system.
3. Check that the HandControl IR is enabled.
4. Check that the charger cable is not connected to an electric outlet.
5. HandControl IR indicates battery change.
6. If the lift works via the operation panel, change the HandControl IR.
7. If the lift motion is stopped during raising maximum load, and then won't raise, try to lower the lift and then raise again.
8. If the problem persists, please contact Hill-Rom.

The lift does not work up/down with the operation panel.

The base-width adjustment doesn't work (in/out) with the operation panel.



1. Make sure that the emergency stop is not engaged.
2. Make sure that the cables to the control box are connected correctly.
3. Check that the charger cable is not connected to an electric outlet.
4. Check the battery capacity.
5. Check that the battery's contact plates are not defective or broken.
6. If the problem persists, please contact Hill-Rom.

The charger doesn't work.



1. Make sure that the emergency stop is not engaged.
2. Check that the charging cable is correctly connected.
3. Make sure that the battery is properly attached.
4. Check that the battery's contact plates are not defective or broken.
5. If the problem persists, please contact Hill-Rom.

The lift is stuck in the high position.



1. Make sure that the emergency stop is not engaged.
2. Check the battery capacity.
3. HandControl IR indicates battery change.
4. Use the electrical emergency lowering device to lower the patient onto a firm surface.
5. Use the manual emergency lowering device to lower the patient onto a firm surface.
6. If the problem persists, please contact Hill-Rom.

If you hear unusual sounds.



Contact Hill-Rom.

2.3 Trouble Shooting Viking™ L mobile lift, 2040034

The lift doesn't work up/down with Hand Control.



The base-width adjustment doesn't work (in/out) with the Hand Control.

1. Check that the emergency stop button has not been pressed.
2. Check the battery capacity.
3. Check that the charger cable is not connected to an electric outlet.
4. Check that the hand control cable is correctly connected.
5. If the lift works via the operation panel, change the Hand Control.
6. *If the problem persists, please contact Hill-Rom.*

The lift does not work up/down with the operation panel.



The base-width adjustment doesn't work (in/out) with the operation panel.

1. Check that the emergency stop button has not been pressed.
2. Check that the cables to the control box are connected correctly.
3. Check that the charger cable is not connected to an electric outlet.
4. Check the battery capacity.
5. *If the problem persists, please contact Hill-Rom.*

The charger doesn't work.



1. Check that the emergency stop button has not been pressed.
2. Check that the charger cables are connected correctly.
3. Make sure that the battery is properly attached.
4. *If the problem persists, please contact Hill-Rom.*

The lift is stuck in the high position.



1. Check that the emergency stop button has not been pressed.
2. Check the battery capacity.
3. Check that the hand control cable is connected correctly.
4. Electrical emergency lowering, use the operation panel to lower the patient onto a firm surface.
5. Use the mechanical emergency lowering device to lower the patient onto a firm surface.
6. *If the problem persists, please contact Hill-Rom.*

If you hear unusual sounds.



Contact Hill-Rom.

2.4 Trouble Shooting Viking™ L mobile lift, 2040044

The lift do not work up/down with Hand Control.



1. Make sure that the emergency stop button has not been activated (shall not be pressed in).
2. Check the battery capacity.
Check if the Li-ION battery has been set in to sleep mode, see chapter "Operation".
3. Make sure that the battery is properly seated in the control box.
4. Check that the charger cable is not connected to an electric outlet.
5. Check that the handcontrol cable is correctly connected to the control box.
6. Check that the lift arm actuator cable is correctly connected to the control box.
7. Check that the base width actuator cable is correctly connected to the control box.
8. *If the problem persists, please contact Hill-Rom.*

The base-width adjustment doesn't work (in/out) with the Hand Control.

The charger doesn't work.



1. Check that the charger cables are connected correctly.
2. Make sure that the battery is properly seated in the control box.
3. Try an alternative mains outlet.
4. *If the problem persists, please contact Hill-Rom.*

The lift is stuck in the high position.



1. Make sure that the emergency stop button has not been activated (shall not be pressed in).
2. Make sure that the battery is properly seated in the control box.
3. Check the battery capacity.
Check if the Li-ION battery has been set in to sleep mode, see chapter "Operation".
4. Check that the handcontrol cable is connected correctly.
5. Electrical emergency lowering, use the operation panel to lower the patient onto a firm surface, see chapter; Operation.
6. Use the mechanical emergency lowering device to lower the patient onto a firm surface, see chapter; Operation.
7. *If the problem persists, please contact Hill-Rom.*

If you hear unusual sound from the lift.



Contact Hill-Rom.

2.5 Trouble Shooting CBL 20

Note! Begin with Simple trouble shooting from Service manual for the actual product. If problem remains continue as described below.

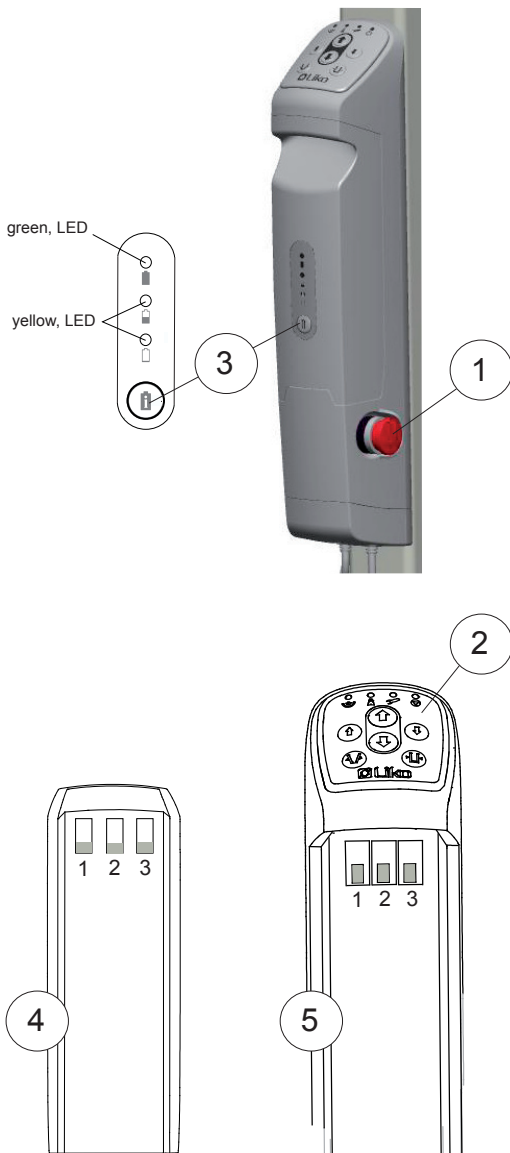
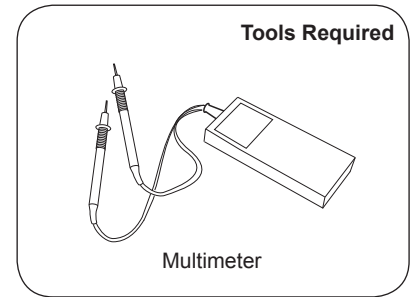

Check point:

1. Make sure that:
 - the emergency stop (1) is not activated.
 - the battery is assembled correctly.
 - the charging cable is not connected to mains.
2. Check operation panel function's for actuator and base motor
 - Push control buttons on operation panel (2) at control box
 - If both actuator and base motor functions response, continue to step 5.
 - If no function, continue to step 3.
 - If only one of either the actuator or base motor function response: change position on actuator and base motor cables then check control function of operation panel, to see if fault is on output channels or the motors. If control box function is ok! Continue to step 5. If control box is faulty. **Replace the control box.**
3. Check battery capacity
 - 3a) Push in the battery capacity button (3):
 - If any of the three LED's on the battery start's the battery is OK, continue to step 4.
 - If not, continue to step 3b.
 - 3b) Measure battery voltage: release battery, (4) measure on contact 1 and 3:
 - If voltage over 0V the battery is ok! Continue to step 4.
4. Verify contact between control box and battery.
 - 4a) Remove the battery and wait for green LED to turn off.
 - 4b) Put back the battery and see if green LED start automatically.
 - If green LED starts, battery contact is ok!
 - If not, try to ensure that the battery's contact plates are not defective or broken and try to bend them out carefully, then repeat step 4.
 - If still no contact, continue to step 5.
5. Check charging function
 - 5a) Connect the charging cable to mains
 - If charging starts within 1 minute, charge and then continue to step 6.
 - If charging doesn't start, continue to step 5b.
 - 5b) Measure output voltage on the control box (5) on contact 1 and 3.
 - If voltage is 3-4V charging is OK! **Replace the battery**, continue to step 6.
 - If voltage is 0V when the charging cable is connected to mains the control box needs to be replaced! **Replace the control box.**
6. Charge the battery until green LED is flashing, on the battery.
 - Check that all function's on the control box is ok!
 - If not, **Replace control box.**

Customers FAQ:

- **The liftarms up/down function or base width in/out function doesn't work?**
 - a) Change position on actuator and base motor cables.
 - b) Perform step 2 and see if fault is on output channel or motors.
- **The control panel function's on controlbox is ok, but the hand control has no function?**
 - a) Check to ensure that battery contact plates in the hand control are not defective or broken.
- **There's no charging function?**
 - a) Verify contact between control box and battery. Perform step 4.
 - b) Check charging function. Perform step 5.

3.0 Spare Parts Assembly Information

INFORMATION

Assembly Instructions to Liko™ spare parts are attached with the products. The assembly instructions are also available in Agile and on the Partner Web. Document number to spare parts assembly instructions can be found in the spare parts list.

Document Number

Cable for handcontrol LR 242S, ES 

Assembly Instruction

Product No. 31290070

Contains:	Qty:
Hand control cabel	1

Fits:	Prod. No.
Hand Control 242 ES 2 Button	3126034
Hand Control LR 242 ES-IMS	3126035
Hand Control LR 242 ES 4 Button	3126036
Hand Control LR 242 ES 6-Button	3126038
Hand Control Ultra Twist	21090059
Hand Control Ultra Control Unit	21090059

Print this document in colour!

Tools required:

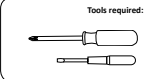

Cable colour

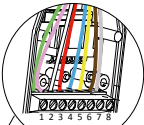

1	Green
2	Pink
3	White
4	Red
5	Blue
6	Yellow
7	Brown
8	Grey

NOTE

- Make sure the spare part is mounted according to the assembly instruction.
- Check all functions related to the changed spare part.
- Repairs and maintenance may only be performed by personnel authorized by Hill-Rom and using original Liko™ spare parts.

3EN50203 Rev. 5
ENGLISH

Enhancing outcomes for patients and their caregivers: 

www.hill-rom.com | www.liko.com

△ NOTE

- Always make sure the spare part is mounted according to the assembly instruction.
- Check all functions related to the changed spare part.
- Repairs and maintenance may only be performed by personnel authorized by Hill-Rom and using original Liko™ spare parts.

Liko™ technical documentation can be found under “My information” - “Documents” on the Partnerweb: <https://partner.liko.com/> If you don't have access, contact Ann-Christin Sundström for registration: E-mail: ann-christin.sundstrom@hill-rom.com, Tel: +46 (0)920 - 47 47 10

4.1 Spare Parts List, Viking™ L mobile lift, 2040004





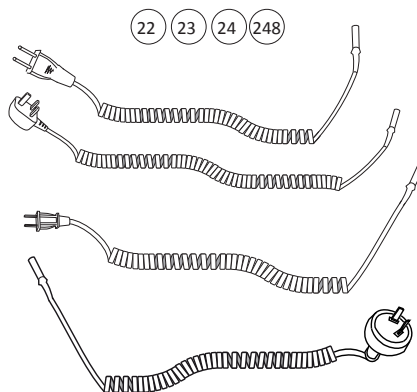
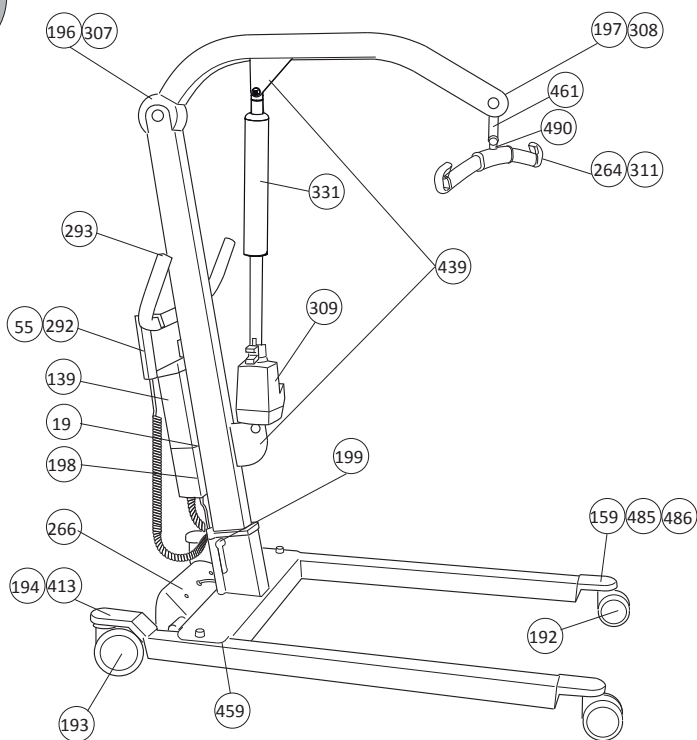

PROD. NO.	PRODUCT
2040004	Viking L (Discontinued 2013) (S/N 7 200 201- 7 300 300)



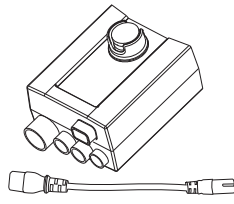
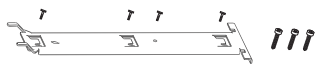
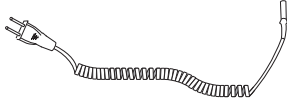

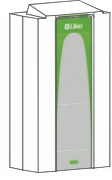
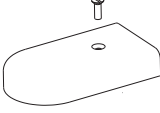

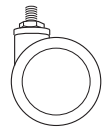
There are four models of Viking™ L mobile lift;
Prod. No. 2040004, 2040014, 2040034, 2040044.
One spare parts list for each model. Make sure to
order correct spare part.

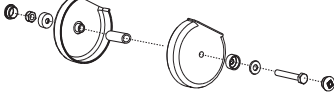

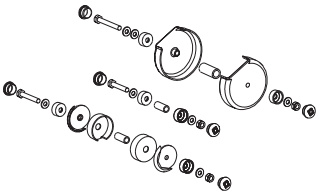
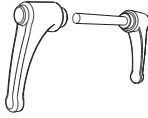

4.1 Spare Parts List, Viking™ L mobile lift, 2040004

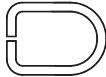
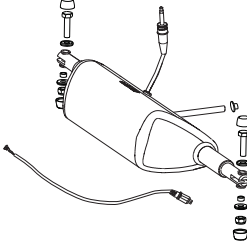
PROD. NO.	POS. NO.	NAME	UNIT		ASSEMBLY INSTR.
20490009	198	Control Box Viking L/XL	pce		3SE630223
20490009US	198	Control Box Viking L/XL, US <i>only for the US-market</i>	pce		
20090023	19	Attachment for Control Box	pce		3EN630238
20090026	22	Cable for Charging, EU	pce		3EN630237
20090027	23	Cable for Charging, UK	pce		
20090028	24	Cable for Charging, US	pce		
20190017	55	Hand Control EE 4-Button	pce		3SE630204
2006106	139	Battery Lead Acid	pce		3EN630224
20390006	159	Fork Cover	pair		183916
21090001	160	Extension Cable	pce		3EN630225
20490003	192	Front Wheel 100 mm <i>We recommend replacing both wheels, as there are two different versions that can vary in appearance. (dimension is the same)</i>	pce		3SE630293
20490004	193	Rear Wheel 125 mm <i>We recommend replacing both wheels, as there are two different versions that can vary in appearance. (dimension is the same)</i>	pce		3SE630294
20490005	194	Rear Fork Cover	pair		3SE630295
20490007	196	Lift Arm Plastic Cover Vi <i>To S/N 7200488.</i>	set		3SE630240

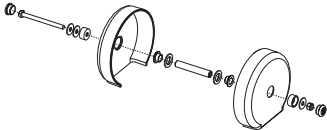
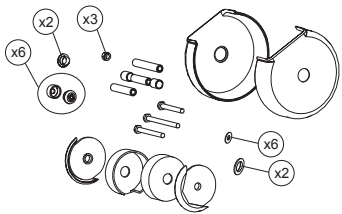
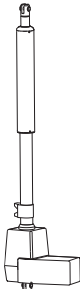
4.1 Spare Parts List, Viking™ L mobile lift, 2040004

PROD. NO.	POS. NO.	NAME	UNIT		ASSEMBLY INSTR.
20490008	197	Overhead Beam Restoration set <i>To S/N 7200488</i>	set		3SE630228
20490010	199	Locking Handle Viking XL <i>from S/N 7200431</i>	pair		3SE630244
20090050	248	Cable for Charging AU/NZ	pce		3EN630237
21090011	263	Extension Cable US	pce		3EN630218
31590011	264	Latch Universal SlingBar	pair		3SE630229
20490011	266	Base Motor Viking M, L	pce		3EN630296
20090058	292	Hook for Hand control 2, 4, 6	pce		3SE630210
20090066	293	End Cover Handle/Arm Support grey, 4 pce	set		3SE630271
20490023	307	Lift arm plastic cover <i>Prod. No. 2040004, from S/N 7200795</i>	set		3EN630250
20490024	308	Overhead beam restoration set <i>Prod. No. 2040004, from S/N 7200795</i>	set		3EN630251
20490025	309	Actuator Viking L, XL	pce		3SE640241

4.1 Spare Parts List, Viking™ L mobile lift, 2040004

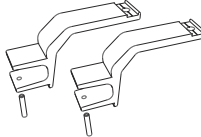
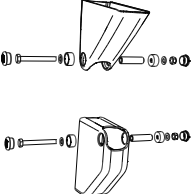
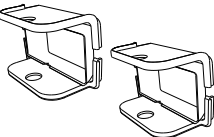
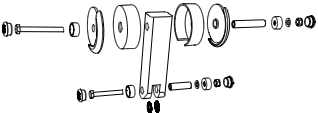
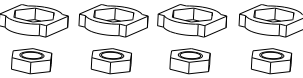
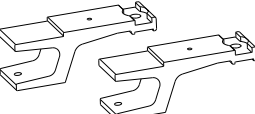
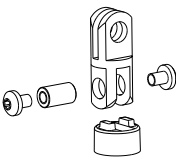
PROD. NO.	POS. NO.	NAME	UNIT		ASSEMBLY INSTR.
31590014	311	Latch, composite <i>Fits Universal SlingBar from S/N 1299511</i>	pair		3SE640242
20490030	331	Outer Tube	pce		3SE640260
20490037	413	Rear Wheel fork	pair		3SE690221
20490040	439	Bracket Cover	set		3SE650273
20490047	459	Leg Cover L&XL	set		3EN650294
20490049	461	Flexlink	set		3SE650295
20090080	485	Fork locking attachment, 4 pair	set		3SE690208
20090081	486	Wheel Fork	pair		3SE690209
20490052	490	SlingBar Assembly set	set		3SE690210

4.2 Spare Parts List, Viking™ L mobile lift, 2040014

PROD. NO.	PRODUCT
2040014	Viking L (with intelligent control box) (S/N 7 800 001- 7 900 000)



There are four models of Viking™ L mobile lift; Prod. No. 2040004, 2040014, 2040034, 2040044. One spare parts list for each model. Make sure to order correct spare part.

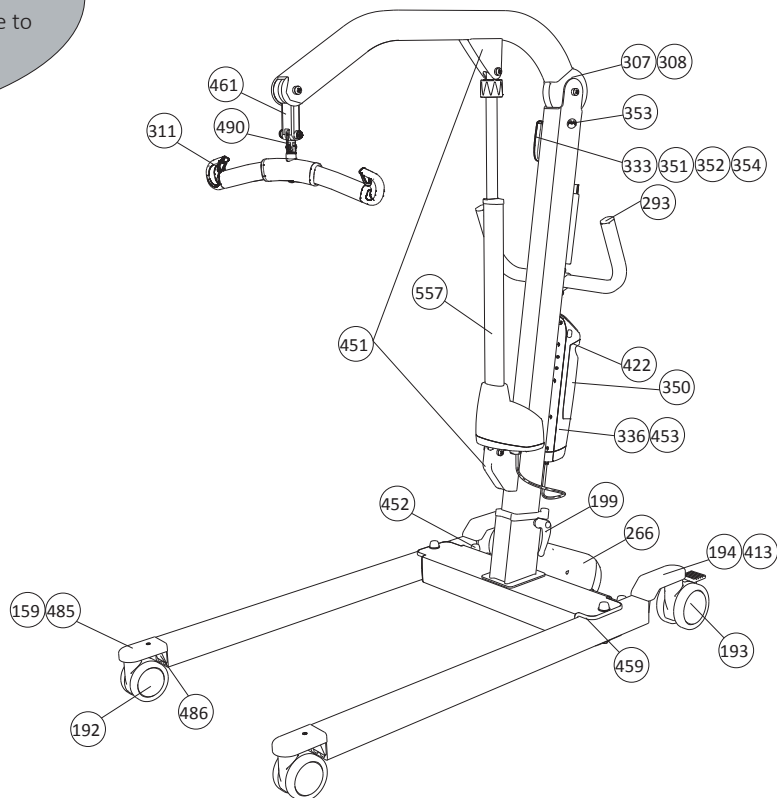
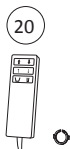

Service Tool

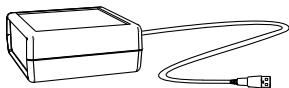

Liko™ Service System







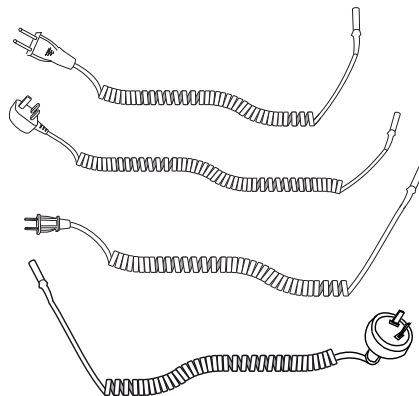

348 349



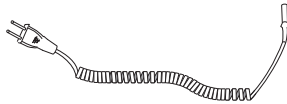

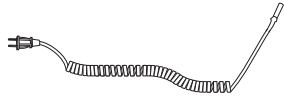
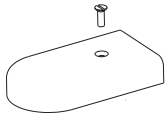

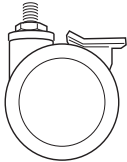

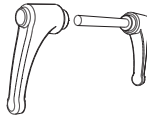
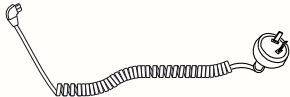



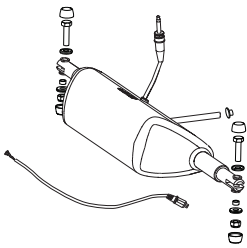

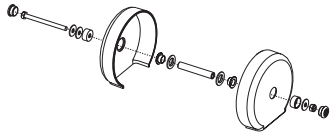
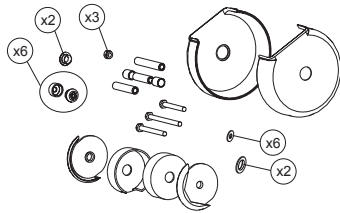
22 23 24 248





4.2 Spare Parts List, Viking™ L mobile lift, 2040014

PROD. NO.	POS. NO.	NAME	UNIT		ASSEMBLY INSTR.
20490039	336	Control Unit CBL, by S/N <i>Can only be ordered if S/N (serial number) can be provided to Liko™ Customer Service. Will be programmed at Liko™ before delivery. 2 weeks delivery time from Hill-Rom/Liko™ Alvik, Sweden</i>	pce		3SE650270
20490043	453	Control Unit CBL, Viking L <i>Before use; requires Software and, needs to be programmed with Liko™ Service System, Prod. No. 21090024</i>	pce		3SE650290
20090026	22	Cable for Charging, EU	pce		3EN630237
20090027	23	Cable for Charging, UK	pce		
20090028	24	Cable for Charging, US	pce		
20390006	159	Fork Cover	pair		3EN380202
20490003	192	Front Wheel 100 mm <i>We recommend replacing both wheels, as there are two different versions that can vary in appearance. (dimension is the same)</i>	pce		3SE630293
20490004	193	Rear Wheel 125 mm <i>We recommend replacing both wheels, as there are two different versions that can vary in appearance. (dimension is the same)</i>	pce		3SE630294
20490005	194	Rear Fork Cover	pair		3SE630295
20490010	199	Locking Handle Viking XL	pair		3SE630244
20090050	248	Cable for Charging AU/NZ	pce		3EN630237

4.2 Spare Parts List, Viking™ L mobile lift, 2040014

PROD. NO.	POS. NO.	NAME	UNIT		ASSEMBLY INSTR.
20490011	266	Base Motor Viking M, L	pce		3SE630271
20090066	293	End Cover Handle/Arm Support grey, 4 pce	set		3SE630271
20490023	307	Lift arm plastic cover	set		3EN630250
20490024	308	Overhead beam restoration set	set		3EN630251
31590014	311	Latch, composite <i>Fits Universal SlingBar from S/N 1299511</i>	pair		3SE640242
20490031	333	Wireless hand control HBL20	set		3SE640298
21090018	348	Extension cable CBL20	pce		3SE650216
21090019	349	Extension cable CBL 20 US,	pce		
2006107	350	Extra battery box	pce		-
21090020	351	Beltclip HBL20	pair		3SE650217
21090021	352	Clips with hook HBL20	pair		3SE650218
21090022	353	Charge cable hook , 10 pce	set		3SE650219
21090023	354	Hand control hanger, 10 pce	set		3SE650220

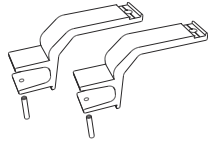
4.2 Spare Parts List, Viking™ L mobile lift, 2040014

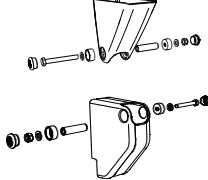
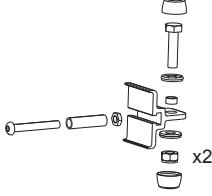
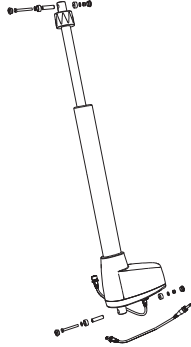
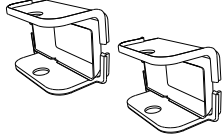
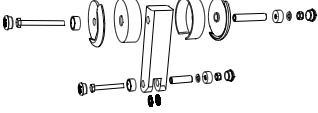
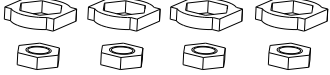
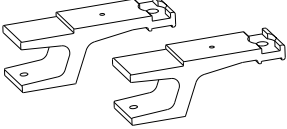
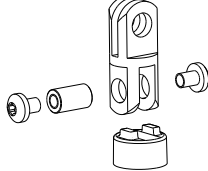
PROD. NO.	POS. NO.	NAME	UNIT		ASSEMBLY INSTR.
20490037	413	Rear Wheel fork	pair		3SE690221
20090077	422	Locking device CBL20, 10 pce	set		3SE640217
20490041	451	Bracket Cover II	set		3SE650287
20490042	452	Restoration set motor attachment	set		3SE650288
20490065	557	Actuator LA44	set		3EN690287
20490047	459	Leg Cover L&XL	set		3EN650294
20490049	461	Flexlink	set		3SE650295
20090080	485	Fork locking attachment, 4 pair	set		3SE690208
20090081	486	Wheel Fork	pair		3SE690209
20490052	490	SlingBar Assembly set	set		3SE690210

4.3 Spare Parts List, Viking™ L mobile lift, 2040034

PROD. NO.	PRODUCT
2040034	Viking L (with intelligent control box and cable hand control) (S/N 9 300 001- 9 400 000)



There are four models of Viking™ L mobile lift; Prod. No. 2040004, 2040014, 2040034, 2040044. One spare parts list for each model. Make sure to order correct spare part.

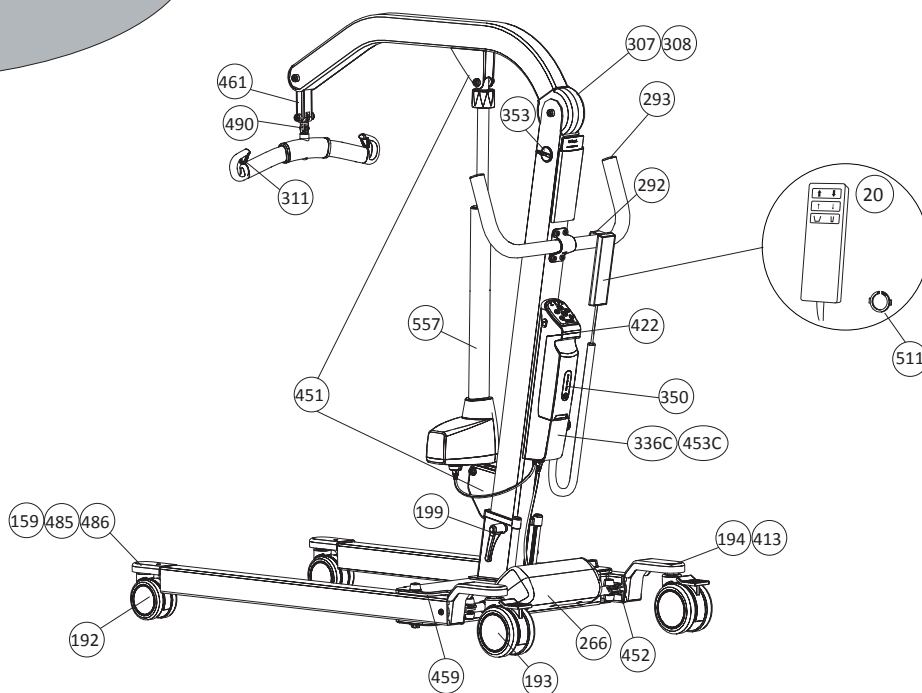



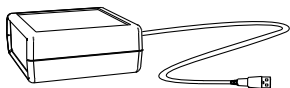



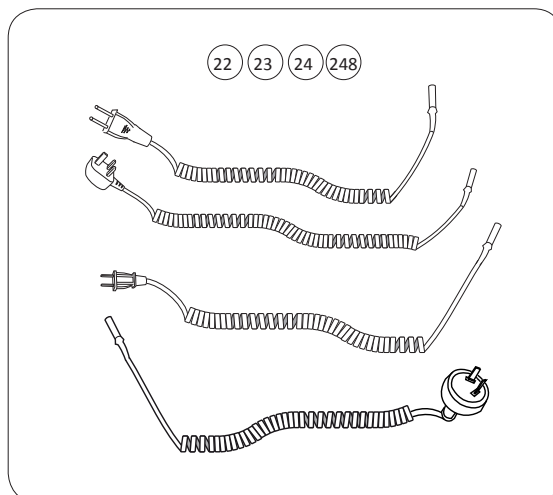
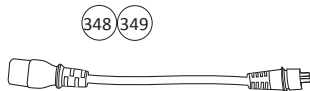

Service Tool

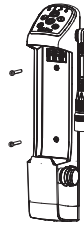

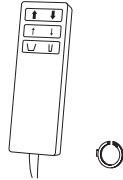
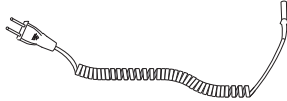

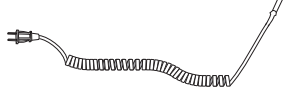
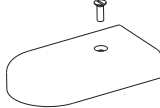

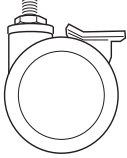

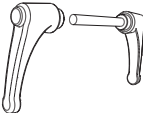

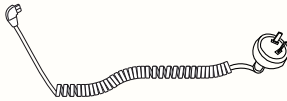
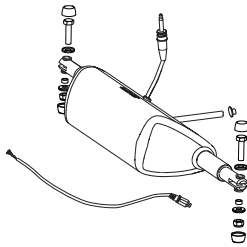
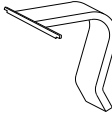

Liko™ Service System

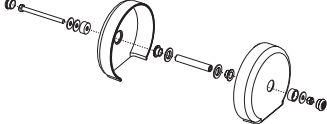
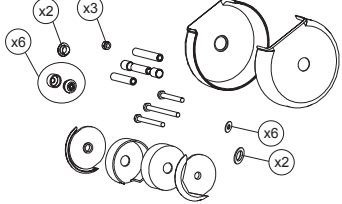

4.3 Spare Parts List, Viking™ L mobile lift, 2040034

PROD. NO.	POS. NO.	NAME	UNIT		ASSEMBLY INSTR.
20490054	336C	Control Unit CBL by S/N, Cable Can only be ordered if S/N (serial number) can be provided to Liko™ Customer Service. Will be programmed at Liko™ before delivery. 2 weeks delivery time from Hill-Rom/Liko™ Alvik, Sweden	pce		3SE690227
20490055	453C	Control Unit CBL Viking L, Cable Before use; requires Software and, needs to be programmed with Liko™ Service System, Prod. No. 21090024	pce		3SE690228
20090089	20	Hand control 6-Button	pce		3SE690232
20090026	22	Cable for Charging, EU	pce		3EN630237
20090027	23	Cable for Charging, UK	pce		
20090028	24	Cable for Charging, US	pce		
20390006	159	Fork Cover	pair		183916
20490003	192	Front Wheel 100 mm <i>We recommend replacing both wheels, as there are two different versions that can vary in appearance. (dimension is the same)</i>	pce		3SE630293
20490004	193	Rear Wheel 125 mm <i>We recommend replacing both wheels, as there are two different versions that can vary in appearance. (dimension is the same)</i>	pce		3SE630294
20490005	194	Rear Fork Cover	pair		3SE630295
20490010	199	Locking Handle Viking XL	pair		3SE630244

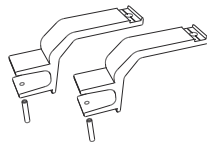
4.3 Spare Parts List, Viking™ L mobile lift, 2040034

PROD. NO.	POS. NO.	NAME	UNIT		ASSEMBLY INSTR.
20090050	248	Cable for Charging AU/NZ	pce		3EN630237
20490011	266	Base Motor Viking M, L	pce		3SE630271
20090058	292	Hook for Hand control 2,4,6	pce		3SE630210
20090066	293	End Cover Handle/Arm Support grey, 4 pce	set		3SE630271
20490023	307	Lift arm plastic cover <i>Prod. No. 2040004, from S/N 7200795</i>	set		3EN630250
20490024	308	Overhead beam restoration set <i>Prod. No. 2040004, from S/N 7200795</i>	set		3EN630251
31590014	311	Latch, composite <i>Fits Universal SlingBar from S/N 1299511</i>	pair		3SE640242
21090018	348	Extension cable CBL20	pce		3SE650216
21090019	349	Extension cable CBL 20 US,	pce		
2006107	350	Extra battery box	pce		-
21090022	353	Charge cable hook , 10 pce	set		3SE650219
20490037	413	Rear Wheel fork	pair		3SE650264
20090077	422	Locking device CBL20, 10 pce	set		3SE640217

4.3 Spare Parts List, Viking™ L mobile lift, 2040034

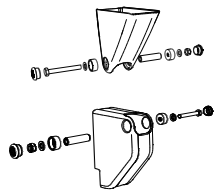
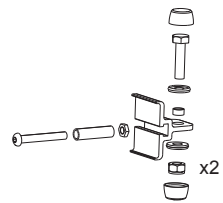
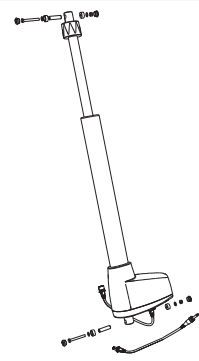
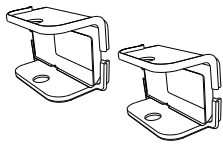
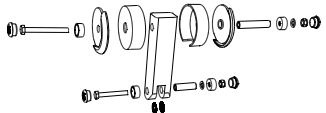
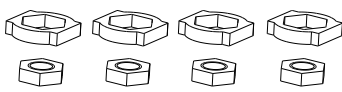
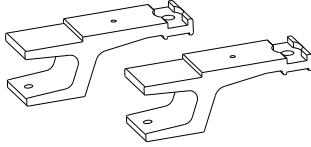
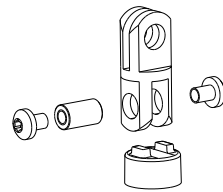
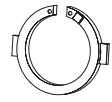
PROD. NO.	POS. NO.	NAME	UNIT		ASSEMBLY INSTR.
20490041	451	Bracket Cover II	set		3SE650287
20490042	452	Restoration set motor attachment	set		3SE650288
20490065	557	Actuator LA44	set		3EN690287
20490047	459	Leg Cover L&XL	set		3EN650294
20490049	461	Flexlink	set		3SE650295
20090080	485	Fork locking attachment, 4 pair	set		3SE690208
20090081	486	Wheel Fork	pair		3SE690209
20490052	490	SlingBar Assembly set	set		3SE690210
20490057	511	Locking Ring CBL, 10 pce	set		3SE690231







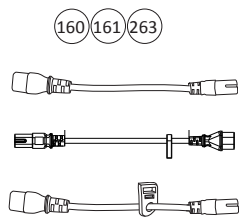
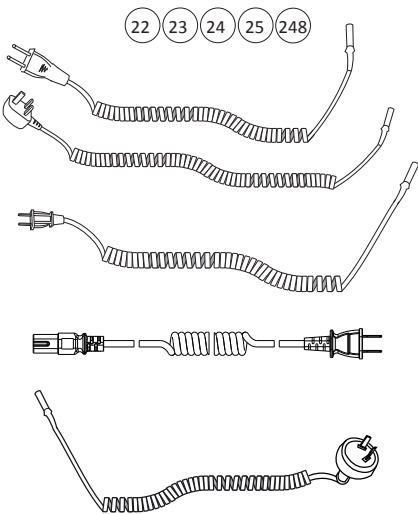
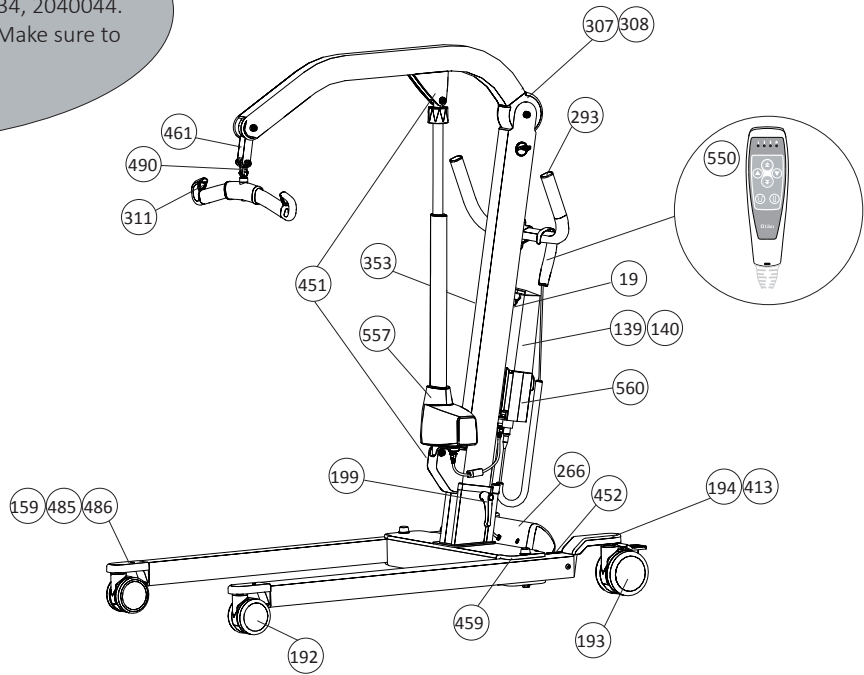

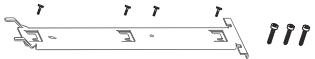
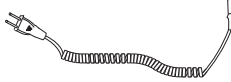

4.4 Spare Parts List, Viking™ L mobile lift, 2040044

PROD. NO.	PRODUCT
2040044	Viking L jumbo care control box and LED hand control (S/N: 9 500 001- 9 600 000)

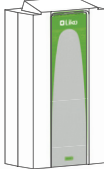
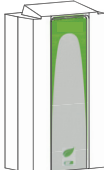
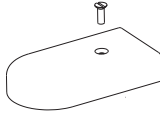





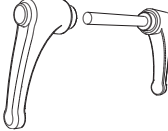

 There are four models of Viking™ L mobile lift; Prod. No. 2040004, 2040014, 2040034, 2040044. One spare parts list for each model. Make sure to order correct spare part.

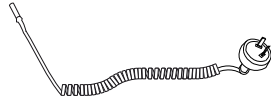

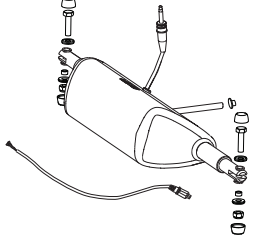

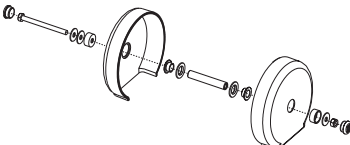
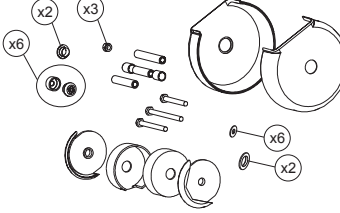
4.4 Spare Parts List, Viking™ L mobile lift, 2040044

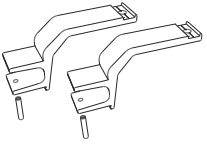
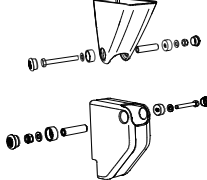
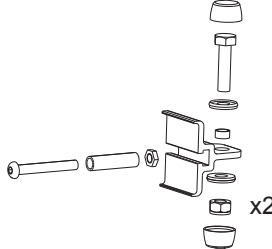
PROD. NO.	POS. NO.	NAME	UNIT		ASSEMBLY INSTR.
20090023	19	Attachment for Control Box	pce		3EN630238
20090026	22	Cable for Charging, EU	pce		3SE630237
20090027	23	Cable for Charging, UK	pce		
20090028	24	Cable for Charging, US	pce		
20090029	25	Cable for charging JP	pce		
2006106	139	Battery Lead Acid	pce		3EN630224
2006110	140	Battery Lithium Ion	pce		User Manual 7EN140108
20390006	159	Fork Cover	pair		3SE380202
21090001	160	Extension Cable	pce		3EN630225
21090000	161	Extension Cable JP	pce		3EN630225
20490003	192	Front Wheel 100 mm <i>We recommend replacing both wheels, as there are two different versions that can vary in appearance. (dimension is the same)</i>	pce		3SE630293
20490004	193	Rear Wheel 125 mm <i>We recommend replacing both wheels, as there are two different versions that can vary in appearance. (dimension is the same)</i>	pce		3SE630294
20490005	194	Rear Fork Cover	pair		3SE630295
20490010	199	Locking Handle Viking XL	pair		3SE630244

4.4 Spare Parts List, Viking™ L mobile lift, 2040044

PROD. NO.	POS. NO.	NAME	UNIT		ASSEMBLY INSTR.
20090050	248	Cable for Charging, AU/NZ	pce		3SE630237
21090011	263	Extension Cable US	pce		3EN630218
20490011	266	Base Motor Viking M, L	pce		3SE630271
20090066	293	End Cover Handle/Arm Support grey, 4 pce	set		3SE630271
20490023	307	Lift arm plastic cover	set		3EN630250
20490024	308	Overhead beam restoration set	set		3EN630251
31590014	311	Latch, composite <i>Fits Universal SlingBar from S/N 1299511</i>	pair		3SE640242
21090022	353	Charge cable hook , 10 pce	set		3SE650219
20490037	413	Rear Wheel fork	pair		3SE650264
20490041	451	Bracket Cover II	set		3SE650287
20490042	452	Restoration set motor attachment	set		3SE650288

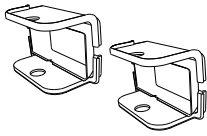
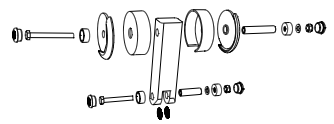
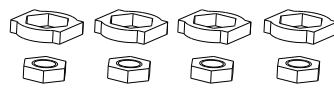
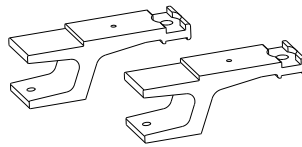
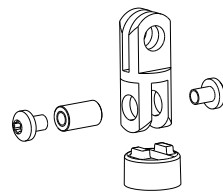
4.4 Spare Parts List, Viking™ L mobile lift, 2040044

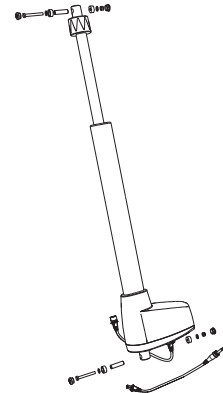
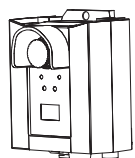
PROD. NO.	POS. NO.	NAME	UNIT		ASSEMBLY INSTR.
20490047	459	Leg Cover L&XL	set		3EN650294
20490049	461	Flexlink	set		3SE650295
20090080	485	Fork locking attachment, 4 pair	set		3SE690208
20090081	486	Wheel Fork	pair		3SE690209
20490052	490	SlingBar Assembly set	set		3SE690210
20090098	550	Hand Control 6 button, LED	pce		3EN690283
20490065	557	Actuator LA44 <i>Replaces 20490045</i>	set		3EN690287
20490068	560	Control Box L Jumbo Care	pce		3EN690289

5.1 Control Unit CBL, Parameter Code Key

Liko™ Diagnostic System™ (operating data) is stored in Control Unit CBL

Parameter:	Information:
TAAxT [Ah]	Totally Accumulated Amphours (current x time)
TAAxTR [Ah]	Totally Accumulated Amphours, resetable (current x time) Can be reset by the manufacturer.
PAAxT [Ah]	Periodically Accumulated Amphours (current x time) Calculated continuously from the moment the lift is used until the first service.
PAKT [Months]	Periodically Accumulated Calendar time. Calculated between services.
TADT [Hours]	Totally accumulated drive time.
AAS [Starts]	Accumulated starts. The number of lifting motions counted from the moment the lift was used the first time.
ASERV [Services]	Accumulated services Number of performed service events made using LSS or LDS.
IMED [A]	Average power consumption during TADT. Overall accumulated operating time.
ALA [Charges]	Accumulatet number of started chargings.
AALA [Charges]	Accumulated number of completed chargings
AOLA [Charges]	Accumulated numbers of not completed charging. Counts each disrupted charging event.
AABT [Removals]	Accumulated number of battery replacements. Counts each battery replacement where a used battery is replaced.
AEUP [Endpos. up]	Accumulated number of end positions during lifting motion up.
AFSERV [Services]	Accumulated number of reset Service Number of "Clear Service" performed manually.
AEDWN [Endpos. down]	Accumulated number of end positions during lifting motion down.
SFSTAT	N/A (This funktion is not in use)
IDNR	Identity number of the control box.
AOLUP [Overloads]	Accumulated number of stops due to overload.
PADT [Hours]	Periodically accumulated operating time.
IMED 20 [A]	Average current consumption. Recounted for each lifting motion (up) which lasts more than 20 seconds.
ELT [Ah]	TAAxTR limit (constant) for ELT indication.
ELTCNT [Commands]	Number of ELT resets (only performed at replacement of actuator).
CLIM_1 [A]	Current limit for lifting motion (up).
CLCT [ms]	Maximum allowed time to override CLIM_1 before cut-off
CLIM_2 [A]	Current limit for widening motion (base-width adjustment).
SINTT [Months]	Indicates service intervals in calendar months.
SINTAS [Ah]	AxT limit for service event. (current x time)
CYCLET [Hours]	Cycle time is a constant for a medium driving cycle.
PAOLUP [Overloads]	Periodic accumulated number of stops due to overload.

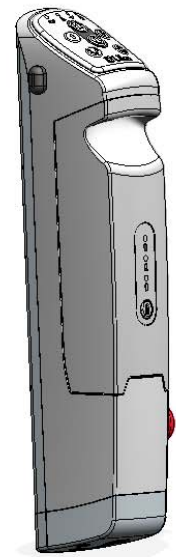



Control Unit CBL

- The information listed above is stored in the Control Unit CBL.
- Replacing the Control Unit CBL without using the LSS may cause some data loss as this data is recordable by LSS and a computer. When data is stored in Liko™ database it can be retrieved if needed.
- Resetting the Service Interval using the LSS, LDS or Manually, will reset the Accumulated Amp-hours (PAAxT), Accumulated Time (PAKT), Accumulated Operating Time (PADT) and Accumulated number of stops due to overload (PAOLUP).

5.2 Control Unit CBL, Reset Service Interval Parameters

CBL RESET SERVICE INTERVAL PARAMETERS

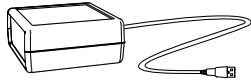
After the Periodic Inspection has been performed Service Light and Service Interval Parameters* in the Liko™ Diagnostic System™ has to be reset. Reset can be done using **one** of the following Service Tools/Methods:

<p>Prod. No. 21090024</p>	<p>1. Liko™ Service System, LSS (Requires a computer) <i>Read and store the data from the Control Unit CBL into a computer. Data can also be transferred to a Liko™ Server. Can also reset the ELT-light (Expected Life Time). Use when Periodic Inspection or Preventative maintenance is performed.</i></p> <p><i>Service Documents for the lift can be printed. Use for tracking and and transfer data when Spare Parts are changed.</i></p>	
<p>-</p>	<p>3. Manual Service <i>Resets the Service Interval Parameters*.</i> △ Service Interval Parameters should only be reset after a complete Periodic Inspection <i>Use the following combination of buttons on the control panel:</i></p> <p><i>A: Press and hold button 1 & 2</i> <i>B: While holding 1 & 2, press button 3, and hold all three buttons for three seconds.</i></p> <p><i>Works from Item No: CBL20001-05, see label on CBL</i></p>	

IMPACT ON PARAMETERS

Changes of parameters when LSS, LDS or Manuel Service reset has been used:

Parameter:	1. LSS:	2. LDS:	3. Manual Service:	Check Points in PM ***
Service Light *	Unlit	Unlit	Unlit	
TAAxT	unchanged	unchanged	unchanged	x ***
TAAxTR	unchanged	unchanged	unchanged	
PAAxT **	0	0	0	x ***
PAKT **	0	0	0	
TADT	unchanged	unchanged	unchanged	
AAS	unchanged	unchanged	unchanged	x ***
ASERV	+1	+1	unchanged	x ***
IMED	unchanged	unchanged	unchanged	x ***
ALA	unchanged	unchanged	unchanged	x ***
AALA	unchanged	unchanged	unchanged	x ***
AOLA	unchanged	unchanged	unchanged	x ***
AABT	unchanged	unchanged	unchanged	x ***
AEUP	unchanged	unchanged	unchanged	x ***
AFSERV	0	0	+1	x ***
AEDWN	unchanged	unchanged	unchanged	x ***
SFSTAT	N/A	N/A	N/A	
IDNR	unchanged	unchanged	unchanged	x ***
AOLUP	unchanged	unchanged	unchanged	x ***
PADT **	0	0	0	x ***
IMED20	unchanged	unchanged	unchanged	
ELT	unchanged	unchanged	unchanged	
ELTCNT	unchanged	unchanged	unchanged	
CLIM1	unchanged	unchanged	unchanged	
CLCT	unchanged	unchanged	unchanged	
CLIM2	unchanged	unchanged	unchanged	
SINTT	unchanged	unchanged	unchanged	
SINTAS	unchanged	unchanged	unchanged	
CYCLET	unchanged	unchanged	unchanged	
PAOLUP **	0	0	0	x ***

* Indicates Service Periodic Inspection interval reached.

** Service Interval Parameters (the PAAxT, PAKT, PADT and PAOLUP are all used to determine Service intervals)

*** Parameters to use in the Preventative Maintenance

5.3 Control Unit Jumbo Care

Control Box operation and information

1. Emergency Stop button
2. Electrical emergency lifting.
3. Electrical emergency lowering.
4. "ON" - lights up green when the charger is connected to mains.
5. "CHARGE" - lights up yellow constantly during charging and will turn off when charging is completed.
6. Display Pop-up information:



Battery power (100- 50 %)



Battery power (50- 25 %) Battery needs charging.



Battery power (Less than 25 %) battery needs charging.
A buzzer will sound when pressing a push button.



Charge the lift immediately! A buzzer will sound when pressing a push button.
The remaining battery power can only make the lift arm go down.



The lift is connected to the mains.



Short circuit warning! Check cables and connections. Warning is shown until repaired!



Overload! Too much load is applied to the lift.



Service indicator. The Jumbo Care control box will be pre-set with a service interval of 12 months / 8000 cycles, whichever comes first. When it is time for service the display will show the service symbol and one single beep will tell that it is time for Periodic Inspection. To get the service data on the display, press "lifting arm up" button (short press ½ sec.) on the hand control or on the control box.

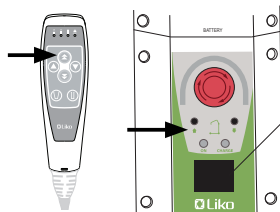
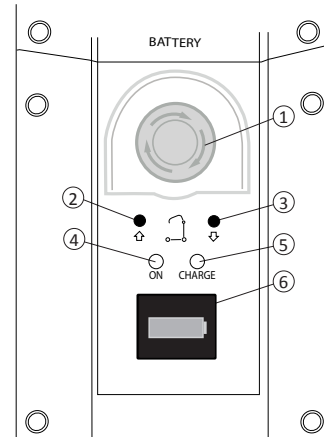

Service data



Total lifting actuator cycles

One cycle is defined as: Driving with load up for a minimum of 5 seconds, following by driving down for a minimum of 2 seconds.



Total lifting actuator work (As)

*Total work made by the lifting actuator.
Recommended max use of As/year: 327 600 As*



Total number of overloads

Counts the number of time the actuator (up/down) has been overloaded.



Days since last service/
days between services

Service Counter shows days since last service/days between services (360).

RESET SERVICE COUNTER

After the Periodic Inspection has been performed the Service Counter (days and cycles until next service) has to be reset.

Before resetting the counter:

It is important to write down the values from the control units in the Periodic Inspection Protocol (3EN371001).

Press the "fast speed" up and down buttons on the hand control or up and down buttons on the control box for 5 seconds.

An audio signal will confirm the resetting.

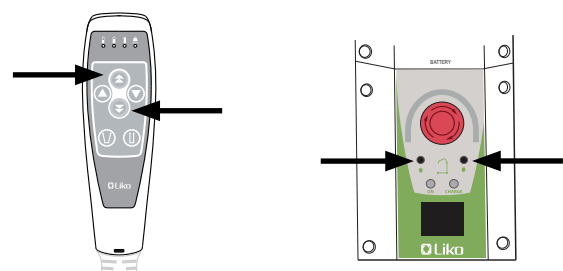

6.0 Liko™ Service System

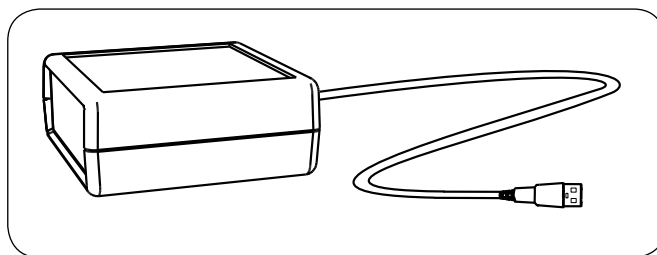

Prod. No. 21090024

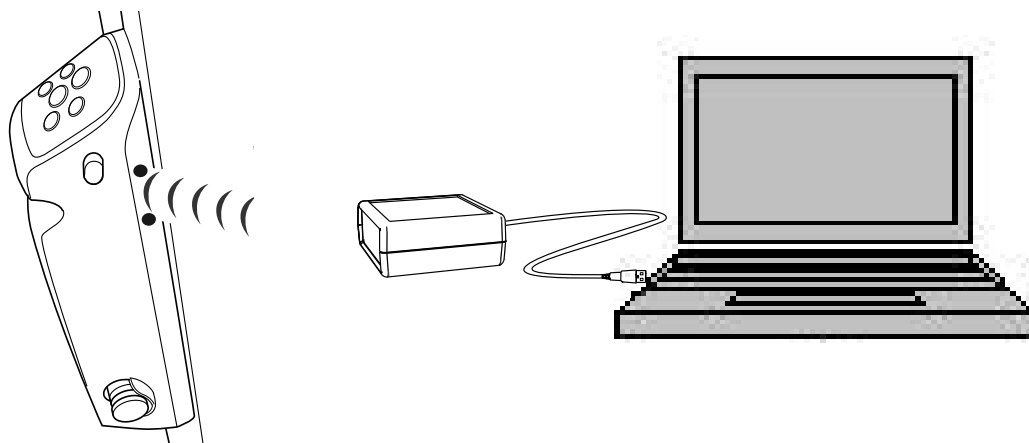

Product Description

Liko™ Service System (LSS) is a soft ware developed to enable service technicians to conduct service in an easy way on all lifts equipped with the control unit CBL 20.

It also gives the service technician the possibility to program the spare part on the field.

Detailed information can be found in the instruction guide supplied with the product.

7.0 Periodic Inspection Information, Viking™ L mobile lift

INFORMATION

According to ISO 10535:2006 Annex B, Periodic Inspection of medical device Liko™ mobile lift should be performed at least once a year. For Liko™ mobile lifts Periodic Inspection Liko™ mobile lifts 3EN371001 is available on the Partner Web (and internally in Agile)

Periodic Inspection
Liko™ mobile lifts
Liko™ sit-to-stand lifts
3EN371001 Rev. 2

Valid for following lifts: Viking™, Galax™, 3EN™, Liko™, M2/M2/200, LikoLight™, Sabina™, Sando™

Lift Information		Customer Information	
Lift:		Approved by:	
Product Number:		Name:	
Serial Number:		Address:	
Production year:		Post Code:	

△ Liko™ lifts must be thoroughly inspected when the Service Light at the Control Unit illuminates (if applicable) or at least once per year. Inspection and service must be carried out by Hill-Rom authorized personnel.

To track how the lift has been used, write down the values from the control unit (if applicable).

Control unit: If the lift has a diagnostic system, an available, data can be read from the control unit (Control Unit, CU). When the lift is not in use, write down the values in the control unit.

As **AC**

Expected life

Control Unit CBU	Control Unit CBU
Viking™ mobile lift 700 Ah	Viking™-L mobile lift 2.175.000 Ah
Viking™-L mobile lift 950 Ah	Viking™-L mobile lift 3.025.000 Ah
Viking™-L mobile lift 800 Ah	Viking™-L mobile lift 3.025.000 Ah
Galax™-R88 mobile lift 700 Ah	Galax™-R88 mobile lift 2.025.000 Ah

If the control unit is replaced the total Ah or Ah will also control whether the control unit but not for the mobile lift.
The mobile lift has an expected service life of 10 years when correctly handled.

Inspection sign off
Complete inspection according to Instructions for the check points (page 3-5), fill in page 2 and sign below.

Approval to use the mobile lift: Approved Not approved

If the mobile lift has one or more inspection points "Not approved" the lift must not be used.
To be authorized Actions according to the "INSPECTION (FRESH) AND APPROVAL" should be performed immediately. After performed actions sign below. If anything is unclear or if you have questions, please contact Hill-Rom or your local Hill-Rom representation.
Contact information to be found at www.hill-rom.com.

Inspection performed on: _____ Date: _____
Inspected by: _____

Inspection performed in accordance with ISO 10535:2006 Annex B Periodic inspection
△ In this document, this warning symbol indicates that special care should be taken.
If instructions are not followed there is a risk of serious injury.

Hill-Rom

NOTE!

△ Periodic Inspection shall be performed at least once per year.

Viking™ L mobile lift 2040044:

The accumulated use of the lift (As) and total lifting actuator cycles should be logged at each Periodic Inspection!

Viking™ L mobile lift 2040014 and 2040034:

The accumulated use of the lift (Ah) should be logged at each Periodic Inspection!

Liko™ technical documentation can be found under "My information" - "Documents" on the Partnerweb: <https://partner.liko.com/> If you don't have access, contact Ann-Christin Sundström for registration: E-mail: ann-christin.sundstrom@hill-rom.com, Tel: +46 (0)920 - 47 47 10

Periodic Inspection may only be performed by personnel authorized by Hill-Rom and using original Liko™ spare parts.

Available Liko™ Periodic Inspections:

- 3EN371001 Periodic Inspection Liko™ Mobile lifts
- 3EN111001 Periodic Inspection Liko™ OH Rail system
- 3EN191001 Periodic Inspection Overhead Lifts
- 3EN301001 PI Freespan Freestand
- 3EN601001 Periodic Inspection Liko™ accessories

Also available is Periodic Inspection Slings. This inspection should be performed by a person who is suitable, has good experience and sufficient knowledge about design, use and maintenance of the sling.







- 7EN160834 General Periodic Inspection Protocol Liko™ Slings and Sabina SupportVests

8.0 Preventive Maintenance, Viking™ L mobile lift

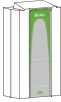
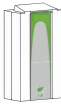
Expected Life Time

The expected life time of a Viking™ L mobile lift is 10 years of normal use or 910 Ah (Prod. No. 2040014 and 2040034) or 3 276 000 As (prod No 2040044) (which comes first) provided that required Periodic Inspection and Preventive Maintenance is performed by personnel authorized by Hill-Rom and using original Liko™ spare parts. However certain parts have a shorter life cycle and will need to be replaced in order for the mobile lift to meet its expected life time. They are listed below:

Parts that needs to be replaced:

Part		Part No.	Replacement interval:	Replacement:
Leg Covers		20490047	6 years or 546 Ah or 1 965 600 As	Can be used more than 6 years if no malfunction is detected.
Battery Lead Acid		2006106	3 years or 982 800 As	Can be used more than 3 years if no malfunction is detected.
Battery Li- Ion		2006110	3 years or 982 800 As	Can be used more than 3 years if no malfunction is detected.
Battery (to CBL)		2006107	4 years or 364 Ah	Can be used more than 4 years if no malfunction is detected.
Hand Control		20190017	2 years	Can be used more than 2 years if no malfunction is detected.
Hand Control		20490031	2 years or 182 Ah	Can be used more than 2 years if no malfunction is detected.
Hand Control		20090089	2 years or 182 Ah	Can be used more than 2 years if no malfunction is detected.
Hand Control		20090098	2 years or 655 200 As	Can be used more than 2 years if no malfunction is detected.

Expected Life Time	Product No.	Year	Work
Viking™ L mobile lift	2040004	10	-
Viking™ L mobile lift	2040014	10	910 Ah
Viking™ L mobile lift	2040034	10	910 Ah
Viking™ L mobile lift	2040044	10	3 276 000 As

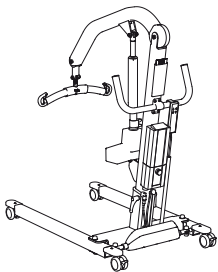

Prod. No. 2040004
S/N. 7 200 201- 7 300 300
(Discontinued 2013)

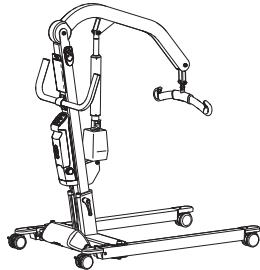

Prod. No. 2040014
S/N. 7 800 001- 7 900 000
(Discontinued 2017)

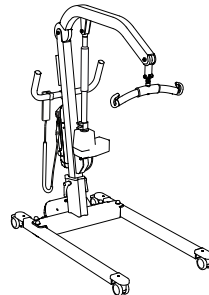

Prod. No. 2040034
S/N 9 300 001- 9 400 000
(Discontinued 2017)

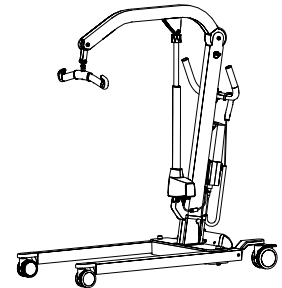

Prod. No. 2040044
S/N 9 500 001- 9 600 000

Changes	Model 2040044 from S/N	Model 2040034 from S/N	Model 2040014 from S/N	Model 2040004 from S/N	Project
---------	------------------------------	------------------------------	------------------------------	------------------------------	---------

2017					
Start of production Viking™ L mobile lift, Prod. No. 2040044 equipped with Jumbo Care Control Box (CBJ-C) and Hand Control HB30. Replacing 2040014 and 2040034.	9 500 001	-	-	-	SUS002056
Viking L, Prod No. 2040014 and 2040034 are discontinued.		-	-	-	MOD005718

2013					
Viking L, Prod No. 2040004 is discontinued.		-	-	-	1740

2012					
New model Prod. No. 2040034 with intelligent control unit and fixed hand control.	9 300 001	-	-	-	1707

2010					
New model Prod. No. 2040014 with intelligent control unit and IR hand control.		7 800 001	-	-	934

Changes	Model 2040004 from S/N	Project
---------	-------------------------------------	---------

2008

4 mm shorter middle beam. Link attachment for base motor adjusted.	7 202 000	671
--	-----------	-----

2007

Outer tube on actuator, and washers in pivot points.	7 201 500	520
New arm and friction washers at link Viking L introduces.	7 200 795	EFR715
Old safety latch back.	7 200 690	619
New safety latch composite.	7 200 664	-

2006

Flourflon grease inside of outer leg casing.	7 200 637	-
Hook composite with safety latch composite.	7 200 591	467
Actuator Viking XL replaces actuator Viking L.	7 200 586	-
Keeps the actuator, Viking XL has different actuator.	7 200 511	432
901890122 Screw M6S M10x40 GL=15 mm change to 930000040 screw M6S M10x40.	7 200 488	-
New pivot points between arm-Mast, actuator-arm, Mast-actuator, arm- link and link-slingbar.	7 200 488	-
New arm. Same as Viking XL, different hole.	7 200 483	-

2005

New screw thread on bolts M6S M10x80 och M6S M10x65.	7 200 483
New length on mast.	7 200 483
New diagonal profile inside the Middle Beam.	7 200 476
New locking handles.	7 200 431
Emergency guard for control box.	7 200 431

2004

New Slingbar "Universal Slingbar 450".	7 200 387
Viking L delivered with the old Slingbar Standard 450.	7 200 285



www.hill-rom.com | www.liko.com

 Liko AB
Nedre vägen 100
SE-975 92 Luleå , Sweden

Enhancing outcomes for
patients and their caregivers: 